

StopLoss

Temperature controlled cargo

Managing risk throughout the cool supply chain



TT CLUB
IS MANAGED
BY THOMAS
MILLER

UKP&I

TT

Contents

1. Introduction p06
 2. The Reefer Cargo Transport Unit (CTU) overview p08
 3. Equipment selection p12
 4. Maintenance, pre-trip inspection and cleaning p14
 5. Cargo packaging p18
 6. Packing cargo into reefer CTUs p22
 7. General principles of packing p23
 8. Reference guide to common commodities and temperatures p29
 9. Importance of in-transit instructions p32
 10. Final mile delivery p34
 11. Post-incident investigations p36
- Operational check list p40
- Glossary of terms p41

Acknowledgements

The information contained in this StopLoss briefing has been formulated from the TT Club's and UK P&I Club's insurance experience. However, the Club gratefully acknowledges the advice and support in the preparation of this guidance of Mark Bennett, Bennett Consulting Associates, Bill Brassington, ETS Consulting, Carsten Jensen, Jensen Associates, Mark Edwards, Modalis and Luc Terral, Bluepulse.

StopLoss series

StopLoss briefings are developed on a broad range of topics that give rise to recurring problems. They seek to provide a straightforward summary of an issue, essential good practice advice and, where applicable, sources of further information. The complete series and further information is available at www.ttclub.com/lossprevention and printed copies are available from the TT Club's Regional Centres.

Disclaimer

The information contained in this briefing has been compiled from various sources. Neither TT Club nor the contributors accept responsibility for loss or damage which may arise from reliance on the information contained herein. Copyright © jointly held by Thomas Miller P&I Ltd and Through Transport Mutual Services (UK) Ltd 2022. All rights reserved. Users of this briefing may reproduce or transmit it verbatim only. Any other use, including derivative guidance based on this briefing, in any form or by any means is subject to prior permission in writing from Through Transport Mutual Services (UK) Ltd.



Managing risk through the cool supply chain

The temperature controlled cargo supply chain can present operational challenges for all stakeholders, these cargoes being amongst the more sensitive transported. Through analysis of claims experience from TT Club and UK P&I Club there are a number of common errors and misconceptions which can result in deterioration or total loss of the cargo, as well as damage to the carrying equipment.

This document is intended to be a practitioner's good practice guide covering all stakeholders throughout the supply chain whether operating, packing, unpacking or handling temperature controlled, 'refrigerated' or 'reefer' cargo transport units (CTUs). It is structured in such a way that it follows the chronology of the supply chain.

Who is this for?

- CTU operator
- Consignor
- Packer
- Shipper
- Road haulier
- Rail haulier
- Intermodal operators
- Carrier
- Consignee

1

Introduction

In this section:

- Supply chain actors as defined by the CTU Code
- The importance of wider guidance

The IMO/ILO/UNECE Code of Practice for Packing Cargo Transport Units (CTU Code)¹ is mentioned throughout this document. Chapter 2 of the CTU Code defines various stakeholders in the supply chain whilst Chapter 4 provides details of the responsibilities of each; the due diligence elements between stakeholders are expanded in MSC.1/Circ.1531². Further perishable cargo advice can be found within the CTU Code Informative Material section IM8.

The table below illustrates how, in today's supply chain, some traditional stakeholders may assume several roles as defined in the CTU Code.

The stakeholders mentioned throughout this document are consistent with those stakeholders identified in the CTU Code. A glossary defining these roles can be found on the inside back cover of this document.

In addition to the guidance and information contained in this document, all stakeholders need to be aware of national, regional and international regulations concerning the preparation and transport of certain commodities, including the capability to provide data records.

	Maintenance /PTI	Cleaning	Selection	Packaging	Cargo packing	Passing instructions	Delivery
CTU operator	●	●	●			●	
Consignor				●	●	●	
Packer					●	●	
Shipper			●	●	●	●	
Road haulier						●	
Rail haulier						●	●
Intermodal operators	●	●	●			●	
Carrier	●	●	●			●	
Consignee		●				●	●

¹ www.unece.org/trans/wp24/guidelinespackingctus/intro.html

² [wwwcdn.imo.org/localresources/en/OurWork/Safety/Documents/MS-C.1-CIRC.1531%20\(E\).pdf](http://wwwcdn.imo.org/localresources/en/OurWork/Safety/Documents/MS-C.1-CIRC.1531%20(E).pdf)



2

The Reefer Cargo Transport Unit (CTU) overview

In this section:

- The history of the reefer container
- Reefer container operation
- Reefer trailers operation

The reefer container

When the first refrigerated containers were introduced during the 1960s, the cooling was initially provided by a central refrigeration plant, which meant that the containers had to be connected through pipes or air ducts before any temperature control could take place. These units were referred to as 'porthole' containers.

The next development was to produce demountable refrigeration (clip-on) units that were attached to the front (porthole) end of the insulated container, which allowed the cargo to be cooled even during road or rail transport. This quickly led to refrigeration machinery that could be incorporated into the containers, and so by the mid

1970s the integrated refrigerated (reefer) container was in operation. An integrated reefer container, as the name suggests, houses its own refrigeration machinery and essentially only requires an electrical supply to operate. The two designs of insulated containers (porthole and reefer) operated in different trades for many years but the reefer quickly became the preferred standard in new trade routes owing to its ease of operation.

Developments in refrigeration technology and the efficiency of container insulation mean that today reefer containers are a reliable and highly cost effective mode of transport for temperature controlled or sensitive cargoes.



Common reefer containers have an operating range between -30°C to +30°C (-22°F-86°F). In response to shipper demands for protecting high value cargo such as sashimi-grade swordfish and tuna, machinery manufacturers have now developed specialised super-low temperature containers with the capacity to maintain temperatures down to -60.°C (-76°F). Common for all is that they are designed to maintain the carried cargo within a given temperature range, with the cooling air provided constantly monitored and regulated by the container's refrigeration unit.

It remains the case that reefer containers for intermodal transport – despite modern ones being able to decrease temperatures over time – are designed to maintain a pre-set temperature only, not lower the temperature of the packed product. Consequently, any frozen product packed for shipment should always be pre-cooled to the desired carriage temperature and any fresh product should be pre-cooled prior to loading to provide the best quality on delivery to the receiver.



... any frozen product packed for shipment should always be pre-cooled to the desired carriage temperature and any fresh product should be pre-cooled prior to loading to provide the best quality on delivery to the receiver



The main cargoes carried within reefer containers are fruits, vegetables, fish, meat and poultry. However, there are many other commodities carried including flowers and pharmaceuticals.

Shippers or consignees may request that the cargo is transported throughout the supply chain under active refrigeration. That means that the machinery must be connected to a power source at all times. Such a requirement may also be stipulated where there is a long road or rail element to and from the maritime terminals. To achieve this, it is essential that a mobile generator (gen-set) accompanies the container(s). The gen-set may be mounted on the front of the container (nose mounted), fitted under the chassis or trailer (underslung) or, for rail transport, fitted into a container (generator container). Active refrigeration is essential where the average ambient temperature is high, taking account of the entire transport movement from point of loading to delivery, and each leg of it.

Some reefer containers are used in a non-operating state within certain trade lanes where empty re-positioning would normally be required. CTU operators should be aware of this practice as transporting other types of cargo can result in increased damage, which increases the risk of inefficient operation, and of contamination. For further information, TT Club has produced Guidelines for the Carriage of Cargo in Non-Operating Reefer Containers³.

³ www.ttclub.com/news-and-resources/publications/stoploss/stoploss-guidelines-for-carriage-of-cargo-in-non-operating-reefers/

The reefer trailer

Refrigerated trailers are understood to have been widely commercially introduced from the 1930s, as a more time efficient alternative to rail cars. The reefer trailer was designed in numerous variations to accommodate differing trade volumes and restrictions.

Reefer trailers are far less standardised when compared to reefer containers. There are a vast number of different options from which to select in relation to size, shape, weight, volume and capabilities. Furthermore, it is possible for trailers to be compartmentalised, therefore having more than one climatic zone, allowing a single trailer to carry both chilled and frozen cargoes concurrently. These trailers may have a movable insulated wall that, when not required, can be hoisted up and secured flat against the ceiling of the trailer. Dual compartment trailers would generally have a secondary evaporator/ refrigeration unit permanently mounted in the ceiling inside the doors. Dual temperature trailers may have an additional access door on one side to facilitate direct access to the front compartment.

The Agreement on the International Carriage of Perishable Foodstuffs and on the Special Equipment to be used for such Carriage (ATP)⁴ sets the standards regarding the specification of reefer trailers; all reefer trailers must conform to the specifications set, in all of the contracting countries⁵.

Whilst the refrigeration machinery may differ in design compared to the reefer container, the principles of its operation are the same; indeed many manufacturers produce units for both trailers and containers.

Reefer trailers are primarily powered by either an inbuilt power pack or connection to the tractor unit, although where longer periods of storage are required they are capable of being plugged into fixed power sources.

In the case of dual compartment trailers, the main refrigeration machinery at the front is larger and has a higher cooling capacity than the secondary refrigeration unit. It is, therefore, generally recommended to transport the most temperature sensitive cargo in the front compartment.

When using dual compartment trailers, it is also important that due care is taken to ensure that the split wall is properly installed and that the gaskets around the edges (sealing the wall against the side walls and floor of the trailer) are intact and provide a true airtight barrier between the two compartments. Where there is significant variation in the temperature requirements for the two compartments (e.g. frozen cargo in one compartment, chilled cargo in the other), leakage from a defect or improperly installed split wall may cause damage to one or both the cargoes carried.

Reefer trailers have two primary options in terms of cooling, either a continuous feed of cool air for chilled/fresh produce or a start/stop system used for frozen cargoes and to some extent non-live chilled cargoes.

Where cargo type is concerned there are no differences between the use of a reefer container or a reefer trailer. The choice in this regard will be influenced by seasonality and market demand. Generally reefer trailers are utilised for shorter land based journeys.

Potential airflow patterns in a dual compartment reefer trailer

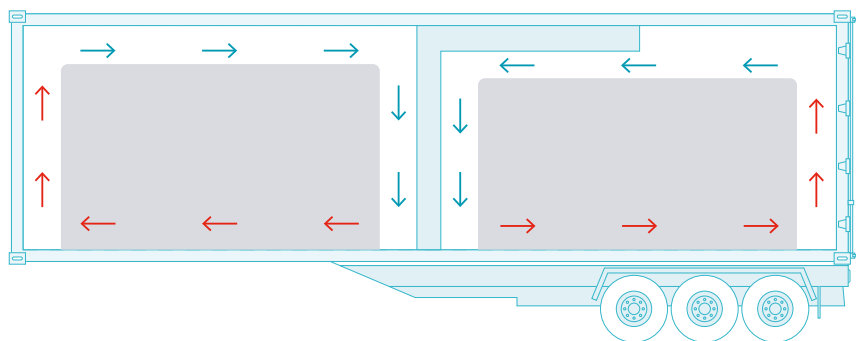

⁴ www.unece.org/trans/main/wp11/atp.html

⁵ https://treaties.un.org/Pages/ViewDetails.aspx?src=TREATY&mtdsg_no=XI-B-22&chapter=11&clang=_en



3

Equipment selection

In this section:

- Standardisation of reefer containers
- The different types of reefer equipment
- The benefits of dual compartment trailers

The selection of the correct equipment is of importance and the key factors are the volume and mass of the cargo to be shipped, the nature of the journey and the required transport temperature.

Integrated reefer containers generally come in 20ft, 40ft or 45ft length and 8ft 6in and 9ft 6in (known as high cube or 'HC') height configurations. Very few 45ft reefer containers exist, with a tendency for use in domestic and intra-regional operations. The vast majority of the global fleet is comprised currently of 40ft HC.

The table below provides a guide to the types of reefer container commonly available and the approximate volume and payload capabilities. This information should only be used as a guide and for specific information you should consult the provider of the equipment being used, as each operator's equipment is likely to differ in precise specification.

The standardisation of reefer containers has been driven by the desire to optimise ship operation and efficiency of space utilisation on-board ships. Trailers on the other hand come in many different sizes and capacities, the maximum sizes dictated by the national and transnational limitations for weight/axle pressures and dimensions allowed, as provided by the road safety laws applicable in the countries where the trailers operate.

Common types of reefer container

Common ISO Reefer size codes	Description	Est volume capacity	Payload
45R1	40' High Cube	67-68.7cbm	Approx. 29,900 - 30,500kgs (65,918lbs-67,240lbs)
42R1	40' Standard	56cbm	Approx. 28,500kgs (62,831lbs)
22R1	20' Standard	29cbm	Approx. 26,000-27,500kgs (57,320lbs - 60,627lbs)

It is common for both trailers and reefer containers that each equipment provider will offer a selection of equipment and service levels to suit industry needs on all trade routes. Below is a list of the more common options:

- The majority of reefer CTUs will have some form of reefer monitoring to provide running information. However, some providers will be able to offer additional remote temperature and condition monitoring potentially accessible by the shipper or consignee; this form of monitoring is becoming more common.
- Specialist reefer CTUs adapted to transport cargoes that need to be hung – for example meat carcasses.
- Specialist dual refrigeration units which are particularly useful in the shipment of sensitive chemicals and pharmaceuticals.
- Specialised reefer CTUs capable of super-low temperature cargoes which need to be transported at temperatures down to -50°C (-58°F).
- Controlled atmosphere CTUs where the interior atmosphere is managed to delay respiration and to extend storage life for fruits and vegetables. Spoiling and moulds are thus minimised.

Where there is a requirement to transport cargoes with different temperature specifications within the same CTU, a dual refrigeration CTU will be required. A dual refrigeration CTU provides two entirely separate cargo spaces in a single unit (generally trailer) and allows, for example, a fresh and a frozen cargo to be carried concurrently.

It is possible to utilise a dual compartment trailer as a conventional single compartment trailer. When doing this, there are some key points that need to be taken into consideration:

- The split wall must be properly stowed; when not in use, it is important that the split wall is locked in place completely flat against the ceiling. If the wall is loose or slanting

downwards, this can cause blockage or restriction of the proper airflow through the trailer compartment. There is also risk of bodily injury or damage to cargo.

- Only the primary refrigeration unit must be operated; the primary refrigeration unit at the front of a dual compartment trailer has the same capacity as in a conventional, single-compartment trailer, capable of providing the required temperature control for the whole compartment when the trailer is not split. If the two refrigeration units are operated simultaneously in one compartment, then they will be distributing cool air towards each other, which will hamper the natural airflow through the cargo compartment and cause uneven temperature conditions.
- Potentially lower stacking height; both the secondary refrigeration unit and split wall take up space at the ceiling, meaning that the maximum stacking height of the cargo is less than for single-compartment trailers. This must be taken into consideration when configuring the cargo to be shipped.

Greater consideration must be given to the volume of cargo to be shipped when selecting a reefer trailer. Too little cargo in a large unit can have a detrimental effect on the efficiency of the airflow and thus affect the quality of the cargo on arrival.

Consideration must also be given to the fact that there is generally a higher propensity to transport consolidated cargoes in trailers. Where this is the case, the reefer trailer doors will be opened more frequently, which will impact the ability to maintain set point temperature.

Where carriage overnight is concerned, the driver will need to ensure that the reefer equipment remains operational through the entire rest period.

4

Maintenance, pre-trip inspection and cleaning

In this section:

- Why run the risk of equipment breakdown?
- Maintenance
- Pre-trip inspections
- Cleaning

Even the newest, most sophisticated machines require maintenance; reefer CTUs are not an exception. To ensure the efficient operation of the reefer CTU, it is essential to keep the equipment in a sound state of repair. Improper maintenance can cause inconvenient downtime, costly repairs and potential loss of cargo. Establishing a preventative maintenance schedule can prove extremely valuable.

Under the CTU Code, the CTU operator, generally the shipping line or leasing company, is responsible to provide a reefer CTU which is fit for purpose.

The structure of all containers, including reefers, should be examined and maintained within the parameters of the operator's maintenance scheme as required by the International Convention for Safe Containers (CSC⁶) as a matter of course. It should be noted, where reefer containers are concerned, that whilst general damage (for example to the side walls) to the container may be acceptable within the parameters of the CSC, such damage may be detrimental to the effective operation of the reefer container and must, therefore, not be overlooked.

The refrigeration machinery will, in addition, require regular maintenance and servicing in line with the manufacturer's recommendations and guidelines. Whilst the recommendations for each model will vary, the service manual will state how frequently specific components, such as the compressor and evaporator, should be fully serviced, and how often filters and other wear and tear components should be routinely replaced.

The reefer container has its own power cable which, when not in use, should be coiled in the designated area at the front of the unit. Failure to do so may result in the cable and plug being damaged during transport that may in turn compromise the electrical integrity of the refrigeration machinery. Refrigeration machines require several kilowatts of energy to operate, which is generally provided by three phase electrical supply. Therefore, if the insulation or conductors within the cable or plug are damaged, there is a serious risk of injury to persons operating the reefers or a fire. Regular checks should be made before connection and whilst in operation to ensure that the power cable is in sound condition and not showing any signs of discolouration.

Smart cargo transport units

Monitoring devices can be deployed not only to provide data concerning the key reefer CTU settings, but also to improve fleet management, ensure efficient operation and optimization.

In addition to enabling remote access to CTU settings, connected devices can deliver a significant operating cost reduction and improve operation quality, thanks to Artificial Intelligence (AI) applications such as:

- Shipment CO₂ emission tracking and reduction.
- Predictive maintenance - lowering maintenance and downtime costs.
- Operation monitoring, tracking events such as abnormal power disconnects.
- Door/latch opening monitoring, detecting CTU security and contamination risks.

⁶ www.imo.org/en/About/Conventions/ListOfConventions/Pages/International-Convention-for-Safe-Containers-%28CSC%29.aspx

Pre-trip Inspections

One of the objectives of the pre-trip inspection (PTI) carried out on every reefer CTU prior to release for packing with cargo is to ensure that the refrigeration machinery is in working order. Many reefer CTUs will have an automatic pre-trip mechanical test completed by the machinery controller. However even though the machinery has been tested before packing, there are instances when the machinery fails during transport. If this takes place on board ships the engineering staff may seek to rectify the problem by undertaking urgent repairs, however this is not always possible due to weather conditions or the container's location.

Most controllers for the refrigeration machinery will include one or more diagnostic routines within the software. Each of these routines may be referred to as a PTI in some format, for example "Brief PTI Test" or "Full PTI Test" or just undertake function tests. They are, however, diagnostic procedures to check that the components are operating within the normal parameters and should not be considered as a replacement for a correctly undertaken PTI. Whilst not an exhaustive list, below are a number of important checks which should be undertaken during the pre-trip inspection.

A "before power on" inspection would seek to ensure that the CTU and refrigeration equipment where applicable, satisfy the following conditions:

- Free from physical damage and in good condition.
- Are not missing components which are key to the operation of the equipment.

- The reefer CTU is sufficiently clean, including ensuring that the CTU is free from signs of mould, plants, pests and other invasive species.
- Any debris such as old labels, placards or remnants of previous cargoes is identified.
- The refrigerant and lubrication levels are sufficient.
- Condenser coils/evaporator and evaporator drain are clean and free from debris.

During the "power on" inspection the efficient operation of the refrigeration machinery should be checked. As described above this is normally initiated by the inspector by selecting the appropriate diagnostic routine on the machinery controller display. The choice of routine selected will determine the diagnostic checks undertaken and on completion of the automatic checks the controller will illuminate either a pass or a fail. Whilst this is being undertaken the inspector should ensure that there are no abnormal noises from components and that the rotation of the condenser and evaporator fans is evident and in the correct direction. The inspector may also initiate a manual defrost routine.

In the event that a reefer CTU fails the PTI, the unit should be marked for repair or maintenance immediately and not released into use.

A CTU operator should determine and document the period of time that a pre-trip inspection is deemed valid; a pre-trip inspection would normally be considered valid for a period of 30 days.



Specifically for pharmaceutical use, but applicable to other products carried, the temperature sensor should be calibrated at least annually and a certificate to this effect examined as part of the pre-trip inspection process.

Cleaning

As part of the PTI, the cleanliness of the CTU should be checked to ensure that it meets the requirement of the shipper. However, and in addition, the presence of pest or pest contamination should also be checked visually (see also the Joint Industry Guidelines for Cleaning of Containers⁷). The CTU Code provides that “all persons involved in the movement of CTUs also have a duty to ensure, in accordance with their roles and responsibilities in the supply chain, that the CTU is not infested with plants, plant products, insects or other animals”. It should be noted that pests and other animals can take residence within the housing of the reefer machinery as well as the loading space.

There are generally three levels of cleanliness in this context.

1. Physically clean – which could be considered as the surface areas appear clean to the naked eye. This could be achieved through sweeping and washing with cold or hot water.
2. Chemically clean – whereby all surface residues which could support microorganisms are removed. This could be achieved through the use of appropriate soaps/chemicals applied to internal surfaces, left for a period and then rinsed clean.
3. Microbiologically clean – where surface residues are free from viable microorganisms including food borne pathogens. There is a need to use more aggressive disinfectants to achieve a deeper clean.

Under the CTU Code, the CTU operator is responsible for providing a reefer container, which is clean and free of debris, cargo residues, noxious materials, plants, plant products and visible pests.

The general design features of the reefer CTU can give rise to some challenges in respect of cleaning activities including non-welded joins in and between the internal side wall panelling and – for containers – the T-bar flooring.



All stakeholders involved in the movement of CTUs also have a duty to ensure, in accordance with their roles and responsibilities in the supply chain, that the CTU is not infested with plants, plant products, insects or other animals⁸



⁷ <https://static1.squarespace.com/static/5ff6c5336c885a268148bdcc/t/60f18dcf-71f7a535433a63a2/1626443221873/CIGCTU+Code++a+quick+guide+Sep+2020.pdf>

⁸ www.imo.org/en/OurWork/Safety/Cargoes/CargoSecuring/Pages/CTU-Code.aspx (see Chapter 8, Annex 5, Annex 6 and IM4)

The use of reefer CTUs to transport general cargo in a non-operating state for re-positioning purposes can also give rise to unexpected contaminants being present after use.

Some cargoes, for example, tuna carried in bulk or other dried fish products, can leave the CTU with significant taint/smell, which may still remain after cleaning. This can subsequently cause taint damage to other cargoes, especially if the next load is fresh fruit or vegetables. Certain fatty cargoes, such as chocolate and butter, are particularly prone to absorbing odours.

Each customer will have their own requirements and expectations in this regard and it is important to ensure that these are clearly communicated to the reefer operator when booking the equipment and transport.

Technology in respect of inspections and cleaning of reefer units continues to progress. Advanced techniques, including inspections under ultra violet light, can assist in readily identifying problem areas in terms of cleanliness⁹.

During the cleaning process, where applicable, operators should ensure that:

- The floor drains are opened.
- There are no obvious signs of damage to non-welded joints (breaks in sealant) that could allow water ingress into the insulation.

- Any debris collected in or blocking the drains is removed.
- There is no evidence of the presence of pest or pest contamination.
- The equipment is thoroughly rinsed and, if washing liquids or soaps are used, ensure that there are no residues remaining.
- The equipment is dry following the cleaning process – there is a risk, otherwise, of freeze damage, ice blockages being formed and corrosion damage when turned on.

Certain cargoes and fumigants, such as Sulphur Dioxide (SO₂) where permitted for use can give rise to corrosion of the reefer container components when moisture is also present. In particular, aluminium corrosion of the internal surfaces of the reefer CTU can be problematic. Evidence of this oxidation can be identified visually and manifest as an accumulation of white powder. This by-product of oxidation is mainly cosmetic, although a potential risk exists of transfer to the cargo itself, which can result in rejection by the consignee. The effects of such corrosion are irreversible.

If corrosion is identified, it should be notified to the CTU operator immediately.



⁹ CTU Code provides further general information in respect of cleaning and cleanliness at Chapter 8.2.4

5

Cargo packaging

In this section:

- The importance of packaging configuration
- Handling chilled and fresh cargoes
- Handling frozen cargo

The correct packing of cargo is one of the more important factors in all types of transport and is particularly affected by the packaging of the commodity, whether it be carton, pallet, net bag or hanging meat. The stow should be stable to avoid damage during handling and in transit, yet it should also promote the desired air circulation through and around the commodity.

Incorrect selection of the packaging design can result in damage to, or loss of the cargo.

Under the CTU Code the consignor is responsible for ensuring that the packaging is sufficient to withstand the rigours of transit, which can be categorised into the following risks:

- Rough handling during packing and unpacking the transport unit.
- Compression from cartons stacked upon one another due to the physical mass of the cargo.
- Humidity during the transit period, compromising the structural integrity of the packaging.

The natural rolling movement of the CTU particularly during carriage by sea and the vibration settling associated with road and rail vehicle transport can result in stack collapse.

It is important to recognise that paper or cardboard based packaging can absorb moisture over time, such cartons gradually get weaker during transport. This process may also lead to stack collapse. For this reason, specialist packaging such as wax impregnated cardboards are sometimes used for chilled products, but with the move towards more environmentally friendly, degradable packaging, the use of treated cartons is decreasing. Hence, it is imperative that a solid carton design is chosen, using multi-ply corrugated cardboard.

If palletised, the cartons should be squared to the pallet to ensure that the pallet supports the cartons and that they are properly secured to the pallet using strapping and corner pieces as appropriate.



Chilled product

Chilled products such as fruit and vegetables are living organisms and produce heat, moisture and ripening gasses as they respire (or breathe), all of which need to be removed during transit. The quantities of heat etc. generated depends on the variety of fruit or vegetable and usually varies with the product temperature. To ensure that these respiration elements are removed, it is essential that a large proportion of the circulating air passes through, rather than around the stow, to give good contact with all parts of the product.

Without sufficient airflow, there is a risk that the correct temperature will not be maintained within the entire consignment, despite the refrigeration unit providing adequate cooling and operating as intended. Furthermore, build-up of ripening gasses from respiration can cause accelerated ripening of the cargo, thereby shortening the storage life of the cargo, and increasing the risk of mould and decay.

Where chilled or fresh cargo is concerned there are variants as to the packaging requirements, dependant on whether you are intending to ship by reefer trailer or by reefer container, as the airflow within each behaves very differently.

As all reefer containers used for sea transport have bottom air delivery/vertical airflow, the packaging for fresh fruit and vegetables being shipped in reefer containers requires ventilation holes in the top and bottom so that when the cartons are stacked, the holes align allowing a clear path for the air to flow through the mass of cargo. The number, size and placement of the holes within the packaging are usually cargo specific so will vary from commodity to commodity.

In reefer trailers, the air is pumped in at the top of the cargo compartment, resulting in a more horizontal airflow. Therefore, packaging for fresh fruit and vegetables being shipped in reefer trailers also requires ventilation holes in the sides so that when the cartons are stacked, the holes align allowing a clear path for the air to flow through the mass of cargo. The number, size and placement of the holes within the packaging are usually cargo specific so will vary from commodity to commodity.

If the packages are stacked and secured on a pallet and where covers are used in the shipment of chilled cargoes it must be ensured that sufficient ventilation is maintained through the pallet and that the covers are properly secured to the pallet.

Shrink wrapping should not be used since it prevents airflow.

Free passage of air

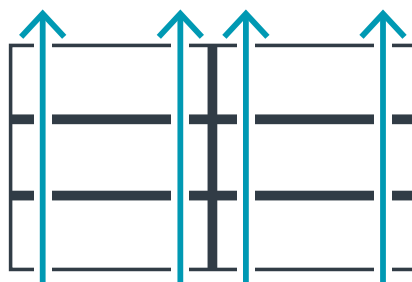

Blocked air passage

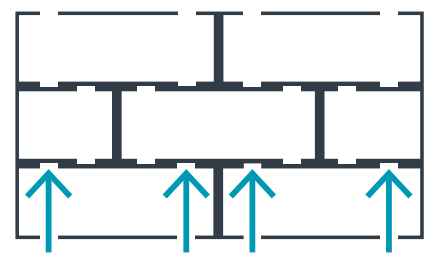

Ventilated carton

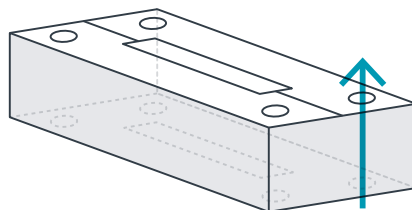

Frozen cargoes

As frozen products do not produce any heat or respiration gasses that need to be removed, there is no need for ventilation holes in cartons used.

It is imperative that the product is properly pre-cooled to the required carrying temperature before packing into the CTU takes place.

Cartons should be stacked directly on top of each other in a 'block stow' (one which has no deliberate spacing between the cartons and pallets), indeed it is preferable that there is no airflow through the block stow, as the core temperature will assist in maintaining the overall temperature of the cargo.



Pharmaceuticals are required by law to show the temperature range within which they should be stored and transported, often referred to as the label claim. Industry regulators police this on a strict basis; pharmaceutical manufacturers should demonstrate that the label claim has been met before their products can be released to market and used by healthcare practitioners.

It has been recognised that reefer transportation presents risks in this area and mitigating action must be taken. The particular risks are when the reefer is not powered, typically during receipt at the port, movement to the reefer stack and ship loading during export operations, then the same points during import. Consequently, various insulation protection products are available to maintain product temperature during those times when the reefer is not powered.

These various solutions each have their own processes, which must be followed as defined by the manufacturer.

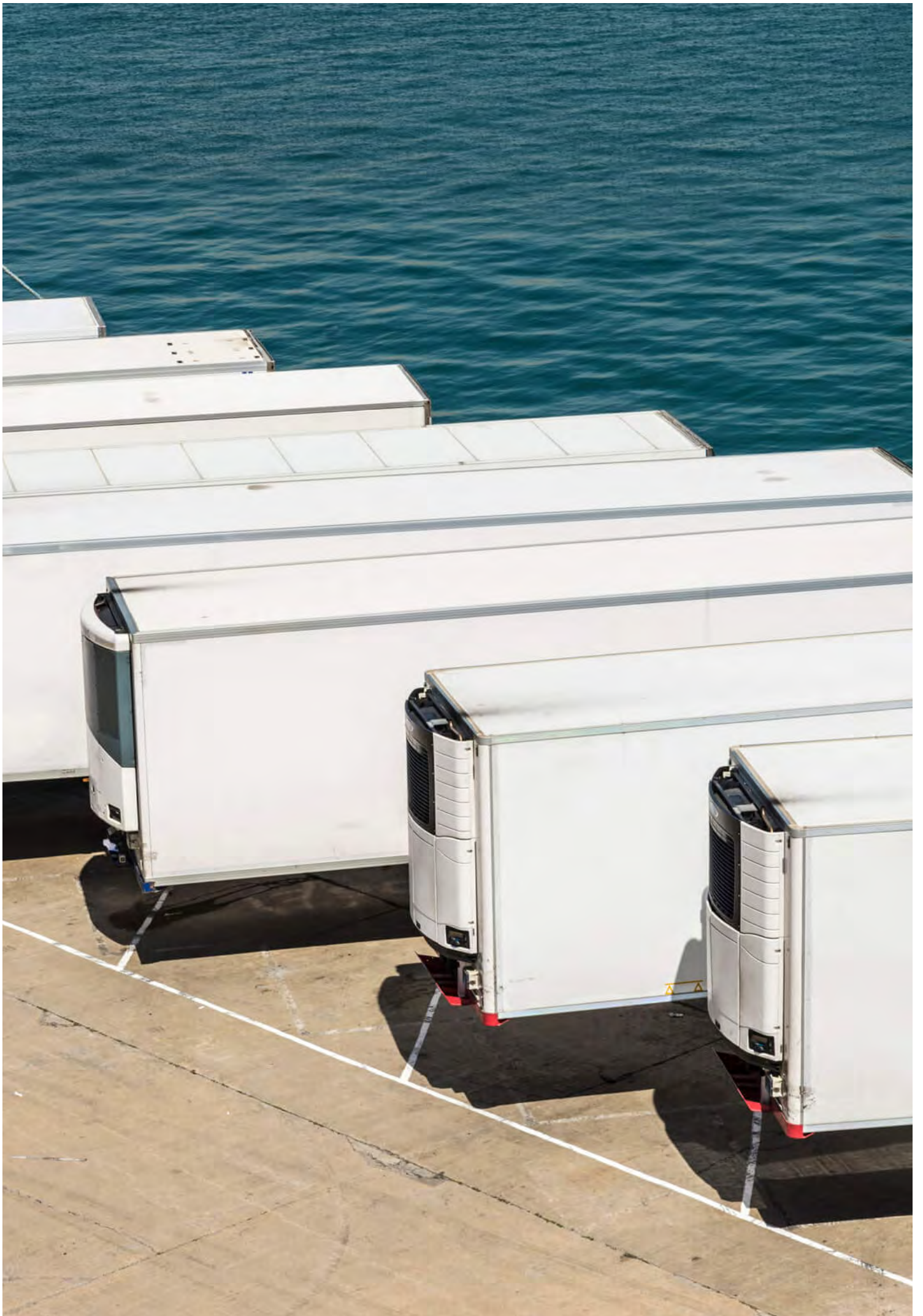

6

Packing cargo into reefer CTUs

In this section:

- Cargo preparation
- Procedures for packing temperature controlled cargo

Pre-checks

Under the CTU Code the packer is responsible for ensuring that the reefer has been checked and verified as fit and clean for use before packing commences. Given the complexities of the supply chain, the shipper or a freight forwarder may be performing the role of the packer.

Where appropriate, the packer should confirm that:

- The reefer CTU is in cargo worthy condition.
- The cargo has been correctly pre-treated. Even with the correct temperature, ventilation and humidity settings, carriage in a reefer CTU will not improve the quality of the cargo.

The cargo needs to have been pre-cooled to the required transport temperature.

Generally speaking, the earlier the transport temperature of the cargo is achieved, the better the quality and the longer the storage life of the product during transport. Remember; a reefer unit is designed to maintain the temperature of the cargo being carried and not lower it.

The reefer unit should be set at the correct transport temperature. Verification should be sought regarding °C and °F and also + or – temperature values.

Ventilation should be set at the correct level in cubic metres per hour (cmh) or cubic feet per minute (cfm) (at temperatures below 0°C (32°F) the ventilation setting must always be closed).

The humidity setting should be at the correct level (at temperatures below -3.0°C (26.6°F) this must always be off).

At temperatures under -0°C the ventilation setting must always be closed

-0°C

7

General principles of packing

In this section:

- Packing into different types of CTU
- Guidance for consolidating different cargoes
- Consider airflow

Under the CTU Code the consignor is responsible for providing all information required for the proper packing of the subject cargo. The packer is responsible for ensuring that the transport instructions are adhered to and that the cargo is sufficiently secured.

Planning

It should be highlighted that there are a number of critical differences between the packing of cargo into a reefer container and the packing of cargo into a reefer trailer, which are addressed in the coming paragraphs.

Packing guidance applicable to both containers and trailers

No fumigants should be used in reefer CTUs such as sulphur dioxide (SO₂). SO₂ can react with moisture in the CTU to produce acids which attack the internal aluminium components, including the T-bar floor (containers), scuff liner and the evaporator coil of the machinery. SO₂ induced corrosion has become a significant cause of damage to reefer CTUs in recent years where shippers have used this fumigant in an attempt to control mould growth or insect infestation.

When preparing the stowage configuration prior to the actual loading into the CTU, it is essential that due consideration is given to the cargo to be carried, and its volume.

For frozen cargoes, subject to proper pre-cooling of the consignment, the purpose of the refrigeration unit is to maintain the temperature of the external faces of the cargo stow to counter the heat transferred through the doors, walls, roof and, to a lesser extent, the floor. This is achieved by cooled air circulating around the stowage (peripheral circulation).

Certain commodities, such as fish, are sometimes transported in bulk (not packaged) and it is imperative that the cargo is sufficiently pre-cooled to the required carriage temperature. This ensures that the cargo maintains its shape and does not deform during packing or in transit; where containers are used the T-bar floor poses that risk. Any deformation of the cargo after packing may reduce the airflow around the cargo stow.

When palletising cargo for shipment, the cargo must be positioned to avoid any vertical voids such as chimney stacking, where unavoidable, spaces should be covered with dunnage.



When preparing the stowage configuration prior to the actual loading into the CTU, it is essential that due consideration is given to the cargo to be carried, and its volume



Packing guidance for reefer containers

Where reefer containers are to be used, whenever possible the cargo should be evenly distributed across the entire floor of the container to ensure the most efficient airflow.

Reefer containers are generally designed and operated with bottom delivery, i.e. that the cooled air is delivered out of the bottom of the refrigeration machinery and directed into the T-bar flooring. It is essential that the channels in the T-bar floor remain clear otherwise the cooled air cannot be delivered to the rear of the cargo as shown below.

Placing all the cargo evenly as a block right from the front of the container immediately adjacent to the refrigeration unit all the way to the end of the T-bar floor at the doors will ensure that the cooled air is circulated around the back of the cargo and presents the least risk to the product during transport.

There are obviously occasions where the cargo is not sufficient in volume to fill the entire load space, where this is the case, the packer should seek to avoid:

- Block stacking to the red load line immediately adjacent to the refrigeration unit as this may result in a seriously asymmetrical load with an eccentric centre of gravity.
- Block stacking the cargo to the red load line in the centre of the load space, thus leaving a large gap between the cargo and the refrigeration unit as this will result in short circuits in the airflow.
- Creating air gaps in the stowage, which would cause an air short circuit and uneven cooling through the cargo compartment during transit. Gaps in the stowage, as well as a large variation in stacking heights, also renders the load more prone to damage from movement during transit.

It is essential that proper planning is undertaken prior to packing to maximise the area covered and to minimise the exposed T-bar floor. Where it is necessary to position the cargo with voids above the T-bar floor, these should be covered with dunnage and air bags to prevent an air circulation short circuit.

Efficient airflow pattern in a reefer container

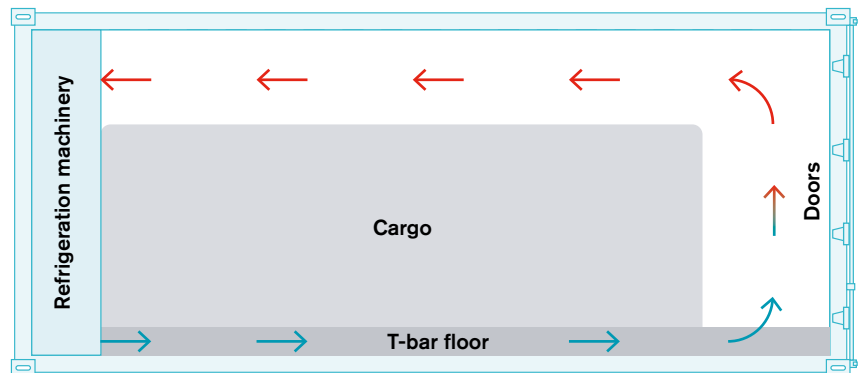

Block stacking adjacent to the refrigeration machinery creates airflow inefficiencies

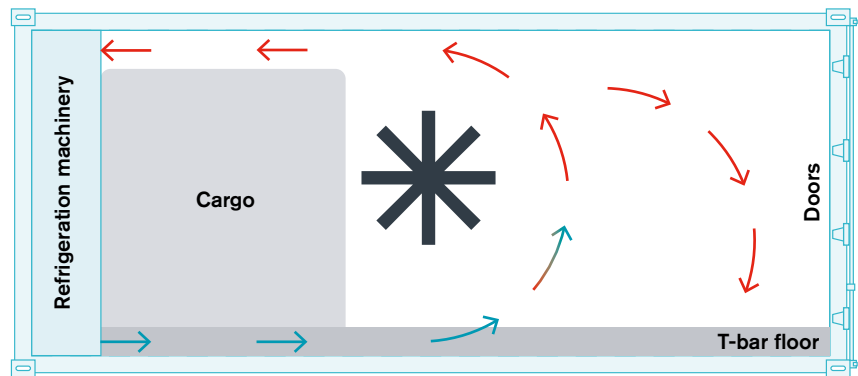

Block stacking in the middle of the load space creates airflow inefficiencies

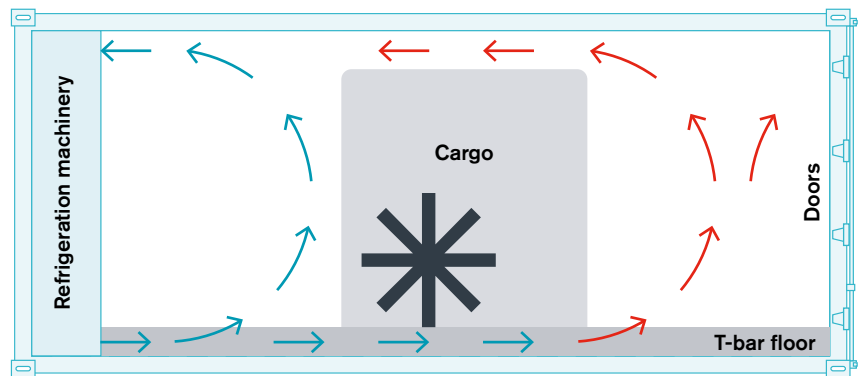

Creating air gaps in the cargo stow will create airflow inefficiencies

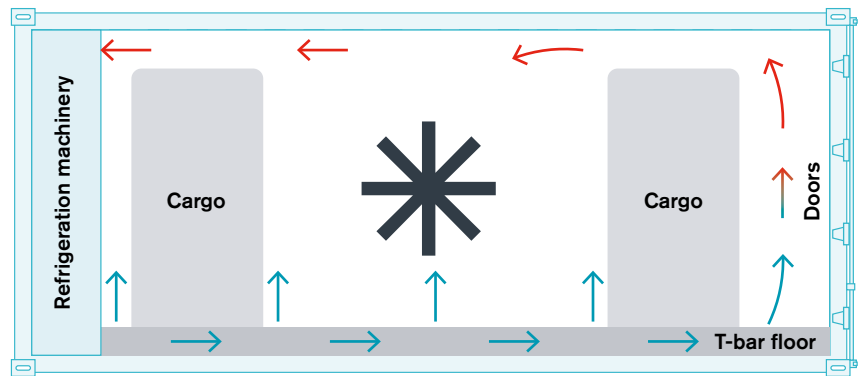

Packing guidance for reefer trailers

Whilst many of the same principles apply, where reefer trailers are to be used, greater consideration needs to be given to the weight distribution of the cargo to ensure that axle weight limits are not exceeded.

In a reefer trailer, the airflow is designed to take a very different path from the refrigeration machinery. Reefer trailers do not have a T-bar floor and are generally designed and operated with top delivery, i.e. that the cooled air is delivered out of the refrigeration machinery across the top of the cargo stow, and is then pulled back through return air ducts placed centrally on the front wall, creating a more horizontal airflow through the trailer as illustrated below.

For transport in reefer trailers, national road safety laws may stipulate that the driver is responsible for the cargo being securely packed inside the trailer and unable to shift dangerously during road transport. The driver is responsible for lashing inside the trailer after stuffing, which is commonly achieved through the use of metal bars that can be installed vertically and/or horizontally where required.

Efficient airflow in a reefer trailer

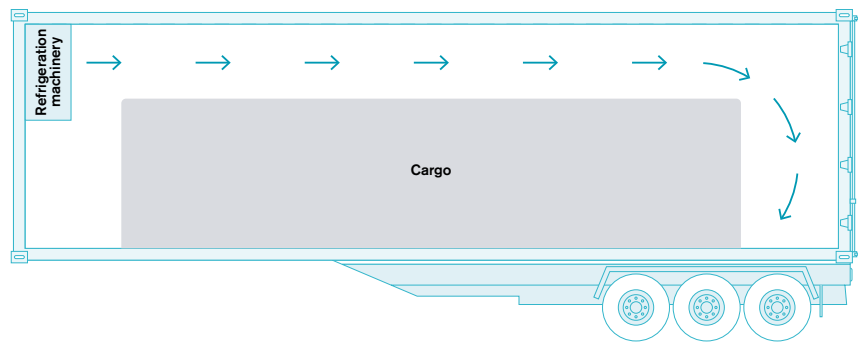

Packing guidance for consolidated cargoes

There is a greater propensity to load consolidated cargoes in reefer trailers where several consignments may be delivered in one trip. When planning to pack consolidated cargoes thought must be given to how the stow will behave after each delivery is made, especially regarding airflow, ventilation and how the remaining cargo will be secured for onward transit.

Due consideration must also be given to consider whether all intended products to be transported together are fully compatible. In this regard, the following points should be considered:

- Do all products have same temperature requirements?
- Are ventilation and humidity requirements compatible?

- Will all products be properly pre-cooled?
- Ripening gasses such as ethylene and CO₂ produced by one commodity may cause accelerated ripening or taint of other commodities.
- Possible tainting of smell or taste (e.g. chocolate transported together with garlic can cause taint of the chocolate).
- Packaging compatibility (for example, non-live product in fully closed cartons stowed next to ventilated fruit cartons in a trailer would block the horizontal airflow).
- Have some products been fumigated or received any treatments that could cause taint to other products?

Efficient airflow for a frozen cargo stow

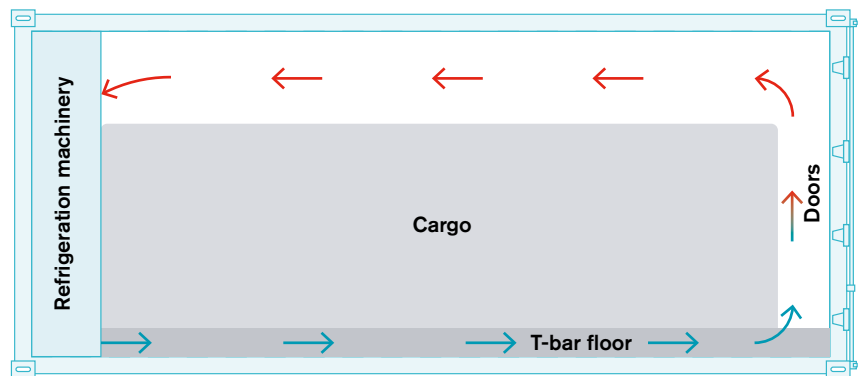

Efficient airflow for a fresh cargo stow

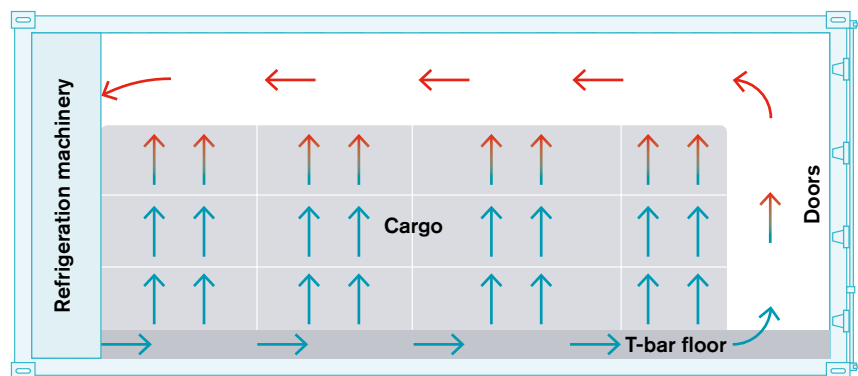
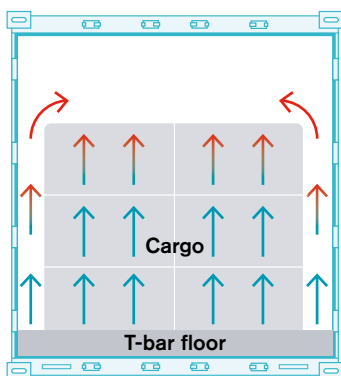

Good practice regarding airflow

The way the cargo is packed within the reefer CTU has a direct impact on the airflow and therefore, the efficient distribution of cooling air and maintenance of temperature conditions throughout the cargo compartment during transit. It is vital to adhere to the following general guidance where applicable:

- Do not run the reefer unit with the doors open or not closed properly.
- Where containers are used do not block the channels at the end of the T-bar floor.
- Where containers are used do not pack cargo beyond the end of the T-bar floor; there may be a rear loading line beyond which the cargo should not be placed.
- Ensure that cargo is not packed above the red maximum height load line.
- Ensure that the airflow is not restricted by the cargo or any packing materials.
- Do not leave any areas open or uncovered on the floor, the front bulkhead or the side walls.
- Ensure that the airflow encapsulates frozen cargoes.
- It is important that cartons are not forcibly pressing against the side walls or doors of the reefer container as this will restrict the efficient flow of air during transit.
- Ensure sufficient airflow through the packaging for chilled cargoes and that there are no blockages to the airflow.

Good practice for packing reefer CTUs

- Ensure that the cargo is packed according to any producer or manufacturer guidelines which may be available for that particular commodity.
- Ensure that the cargo is stable on the floor of the CTU.
- Ensure that the total cargo mass does not exceed the maximum payload of the reefer CTU and where appropriate the respective axle weight limitations.
- Ensure that the total gross mass of the reefer container (cargo + container + dunnage) does not exceed the maximum permissible operating gross mass of the container or any road or rail limitations in any country passed through during the planned transit.
- Close the doors of the unit immediately once packing has been completed.
- Where mandated, or specified by the customer, seal the CTU.



For pharmaceutical products, the reefer should be pre-conditioned i.e. it should arrive at the loading facility with the internal temperature already at the set point. Typical label claim temperature ranges for pharmaceuticals are 2°C (35.6°F) to 8°C (46.4°F) and 15°C (59°F) to 25°C (77°F) with set points at 5°C (41°F) and 20°C (68°F) respectively. The loading should take place in a temperature controlled facility so the reefer should remain operational during loading.

8

Reference guide to common commodities and temperatures

In this section:

- Guide to commonly carried cargoes
- Set point temperature

Common cargoes

It is important for all stakeholders in the cool supply chain to have a basic knowledge of common temperature ranges for various cargo types. Thus, for example, if instructions are received to transport a consignment of frozen fish at +25°C, the instructions should be questioned, thus potentially preventing a loss.

The below chart provides guidance as to the common temperature ranges and settings for a selection of commodities which may assist an operator to validate the instructions presented. The data contained within this chart should be used as a guide only and should not supersede the data provided by the shipper.

Where chilled and fresh produce are being transported, each specific consignment will be unique. Whilst not exhaustive the following factors will impact the decisions and cargo care required:

- routing, modes and duration of the transit
- the ripeness and related characteristics of the commodity
- the seasonal or regional climate in the growing areas.

All such factors may require slightly different temperature settings to maintain the quality of the produce.



As can be seen, transposing °C with °F or vice-versa would have a major effect on the cargo. For example milk, that

should be transported at 0.5°C would be frozen if the refrigeration machinery was set to 0.5°F (-17.5°C).

Temperature reference guide for commonly carried cargoes

	Commodity	Celcius (°C)	Fahrenheit (°F)
Frozen	Sashimi-grade swordfish and tuna	-50.0	-58.0
	Frozen fish	-28.0	-18.4
	Ice cream	-26.0	-14.8
	Frozen butter	-18.0	-0.4
	Frozen meat	-18.0	-0.4
	Frozen fruit	-18.0	-0.4
	Garlic fresh	-2.0	28.4
	Chilled meat	-1.0	30.2
Chilled	Peaches	0.0	32.0
	Kiwi	0.0	32.0
	Grapes	0.0	32.0
	Milk pasteurised (chilled)	0.5	32.9
	Butter	1.0	33.8
	Apples	2.0	35.6
	Avocado	5.5	41.9
	Chocolate (chilled)	8.0	46.4
	Bakery products (chilled)	10.0	50.0
	Lemons	12.0	53.6
	Bananas	13.3	55.9

Set point temperature

There are several factors which need to be considered when carrying cargo in reefer CTUs; temperature is perhaps the most obvious. Ensuring the correct temperature setting is critical to the quality of the cargo being carried.

There are a number of common operational errors made around temperature selection which can be easily avoided, including:

– the choice of degrees Celcius (°C) or degrees Fahrenheit (°F) or selecting a “-” value rather than a “+” value.

– confusion between the unit of measurement at certain levels, for example; 0°C (a common chilled value) and 0°F (a common frozen value).

Recognising that each and every cargo will have its own requirements, there are some commonalities which can be of general assistance.

Reference conversion chart from Celsius to Fahrenheit

Celsius (°C)	Fahrenheit (°F)	Celsius (°C)	Fahrenheit (°F)
-60	-76.0	-8	17.6
-58	-72.4	-6	21.2
-56	-68.8	-4	24.8
-54	-65.2	-2	28.4
-52	-61.6	0	32.0
-50	-58.0	2	35.6
-48	-54.4	4	39.2
-46	-50.8	6	42.8
-44	-47.2	8	46.4
-42	-43.6	10	50.0
-40	-40.0	12	53.6
-38	-36.4	14	57.2
-36	-32.8	16	60.8
-34	-29.2	18	64.4
-32	-25.6	20	68.0
-30	-22.0	22	71.6
-28	-18.4	24	75.2
-26	-14.8	26	78.8
-24	-11.2	28	82.4
-22	-7.6	30	86.0
-20	-4.0	32	89.6
-18	-0.4	34	93.2
-16	3.2	36	96.8
-14	6.8	38	100.4
-12	10.4	40	104.0
-10	14.0	42	107.6

The data above should be used as a guide only and should not supersede the data provided by the shipper.

9

Importance of in-transit instructions

In this section:

- Concise instructions
- Complexity of reefer supply chains
- Practical checks

Instructions

Each stakeholder in the supply chain has a responsibility to pass all the appropriate information regarding the cargo and transport requirements to the next stakeholder so that the cool chain is maintained, and the cargo remains at the required transport temperature and settings. Careful scrutiny of the instructions at each stage is fundamental to the successful shipment of temperature controlled cargoes.

Under the CTU Code the consignor is responsible for ensuring that the cargo is correctly described and to notify the packer/freight forwarder of any specific instructions in relation to the pending shipment.

Cool supply chains are often complex with multiple stakeholders involved. When claims arise, it is often due to simple instructions between the various stakeholders highlighting the need for the reefer container to be plugged in and under power which have been overlooked, which can have a devastating impact on the quality, or total loss of the cargo when it reaches its destination.

Poorly worded notations can also be an attributing factor, ambiguity where instructions are concerned should be avoided. Where instructions appear to be less than certain, the stakeholder should seek clarification prior to proceeding.

Each stakeholder taking delivery of a reefer container and cargo should undertake a number of checks such as:

- Pause to consider whether the information received is complete and makes sense.
- Ensure that the required set point temperature on the shipping documents corresponds with the setting on the reefer container itself.
- Ensure that the receiving stakeholder confirms that the reefer is operating and under power after interchange.
- Ensure that, where used, generators are properly connected and have sufficient fuel for the entire remaining journey.
- For frozen cargoes, ensure that the ventilation, humidity and controlled atmosphere settings are in the off position with ventilation closed.
- For chilled cargoes, ensure that the required ventilation, humidity and controlled atmosphere settings are communicated and strictly followed.



Careful scrutiny of the instructions at each stage is fundamental to the successful shipment of temperature controlled cargoes



When transferring the reefer CTU between stakeholders, for example between the port and the road haulier, each party should keep Equipment Interchange Receipts (EIRs), stating the time the reefer CTU was transferred (i.e. picked up and left the port). This document should also include confirmation of the transport instructions and settings.

Where appropriate, each stakeholder in the supply chain should consider the potential language barriers faced by subsequent stakeholders. There may be a requirement to provide translated instructions, therefore avoiding a potential loss through misunderstanding.

Where particularly sensitive cargoes are concerned, additional communications may be appropriate between stakeholders. It is good practice to develop a procedural audit trail to verify instructions have been passed.

Practical checks

It is critical that the reefer CTU is checked throughout the journey along the supply chain. The care, custody and control of a reefer CTU will likely pass to several stakeholders in any given transport. The reefer CTU should be checked to ensure that the set temperature is correct and that the reefer is operational at each interchange through the supply chain by both stakeholders. Where a single stakeholder has the reefer CTU in its care, custody and control for an extended period, checks should be undertaken periodically at intervals of not more than 12 hours.

As a general rule, a reefer CTU should not be left off power for any prolonged period through the supply chain. In particular, ship to shore or shore to ship operations can give rise to delays in this context and should be managed carefully to ensure that the reefer CTU remains under power wherever practicable.

The complexities of a modern cool supply chain

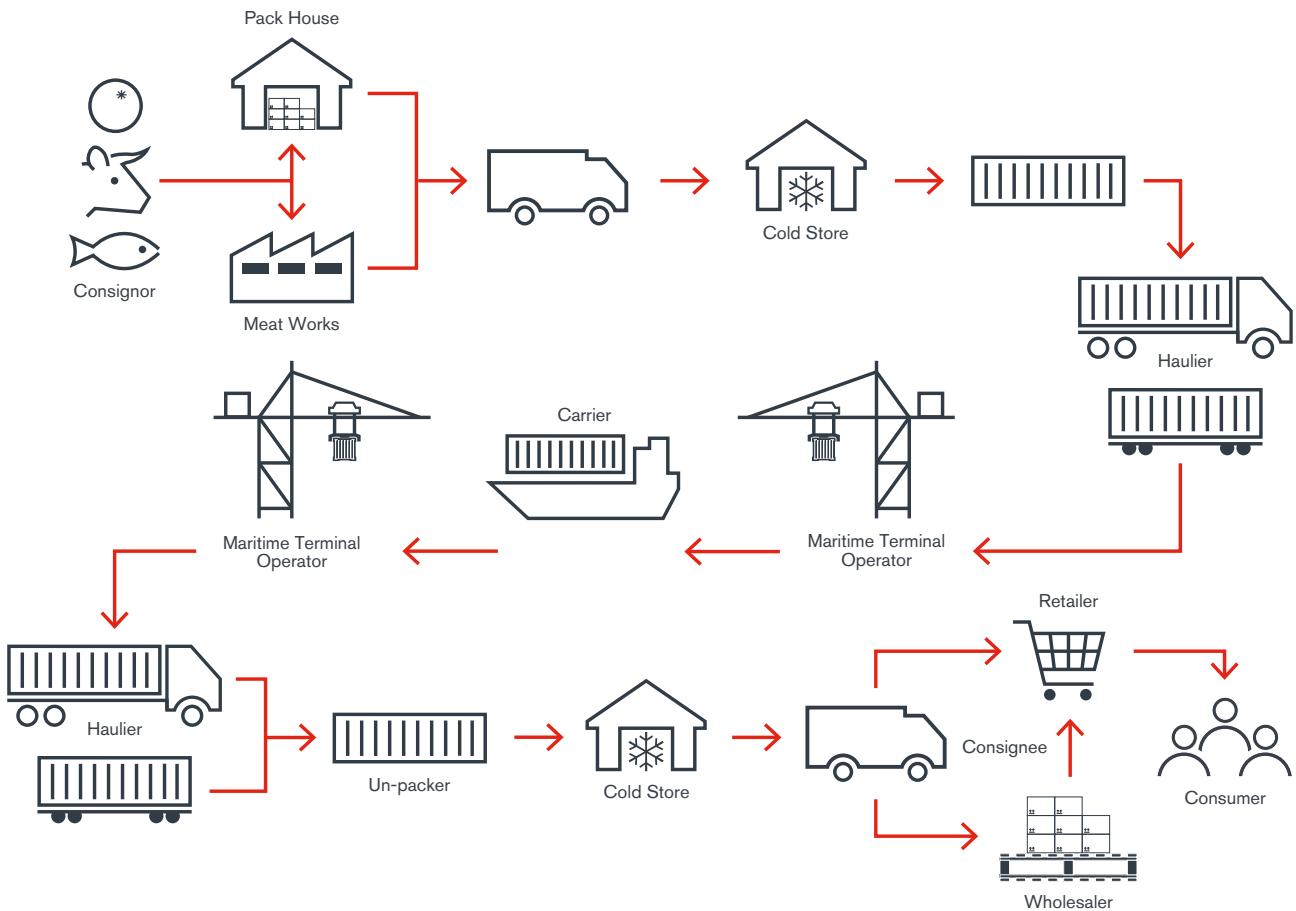

10

Final mile delivery

In this section:

- Practical checks upon collection at the port of arrival
- Responsibilities of the consignee
- Cargo: sample temperature testing

Final mile delivery to the consignee

At the time the reefer CTU is picked up from the port or depot for delivery to the consignee, the following checks should be carried out by the collecting driver, regardless of whether the inland haulage is arranged by the carrier or the consignee:

- Visual check that the reefer CTU appears structurally sound.
- The security seal remains intact and displays the correct seal number.
- Temperature setting on the reefer machinery is the same as the transport documentation.
- Ventilation setting on the reefer machinery is the same as the transport documentation.
- Humidity setting (if used) on the reefer machinery is the same as the transport documentation.
- Controlled atmosphere settings (if used) on the reefer machinery is the same as the transport documentation.

Upon arrival at the delivery point, the consignee should always carry out the same initial checks of the reefer CTU structure, seal and settings as listed above, to the extent this is practically possible.

Under the CTU Code the consignee is responsible for:

- Ensuring that the floor of the reefer CTU is not overstressed during the unpacking process.
- Reporting any damage to the reefer CTU after unpacking.
- Returning the reefer CTU completely empty and clean.

The reefer CTU doors should be opened carefully to avoid injuries if the cargo has moved in transit and spills out with the opening of the doors. If the interior had a high humidity, or was not at the required transport temperature before packing, or if the cargo was not at its transport temperature, there is a risk that the doors may be frozen shut. Extra care must be taken to open the doors without damaging the structure.

Allow time for the interior atmosphere to equalise with the cold store or exterior before entering the container. Only once the interior atmosphere has equalised with the outside should any person enter the container. This is to ensure that the air within is breathable.

When the reefer CTU doors are opened, the consignee, from outside the container, should firstly check whether the consignment appears to be correctly stowed inside the container and pallets or packaging are still intact.

In the event that any quality irregularities are noted immediately upon opening the doors, or in connection with unloading the first cartons, the consignee should stop further unpacking, notify the carrier and arrange for a surveyor to attend, prior to completing the unloading.

In cases where quality irregularities are only noted after the reefer CTU has been fully unpacked, the consignee should endeavour to notify the carrier as soon as possible, and an independent survey should be arranged. There may be a number of insurance stakeholders interested at this stage and they should be notified and asked for instructions.

The consignee should initially visually check the subject cargo for compliance with expected specifications and quality and is in sound condition. Further probe testing may be required:

- Chilled cargoes should be subjected to destructive probing (temperature probe pushed into the produce).
- Frozen cargoes should be subjected to applying a temperature probe between the cartons. However if the readings show temperatures slightly above the set point temperature then destructive probing should be considered sacrificing one of the cartons.

Temperature at the core of the cargo is likely to be different than that between layers of packaging.

Where the reefer CTU is not unpacked at a conditioned unloading bay, it is important to transfer the cargo from the reefer CTU to the cold store without delay. Exposing the cargo to ambient temperature and humidity level may result in the loss of or damage to the cargo.

Temperatures fluctuate differently depending on the position of the carton in the stow

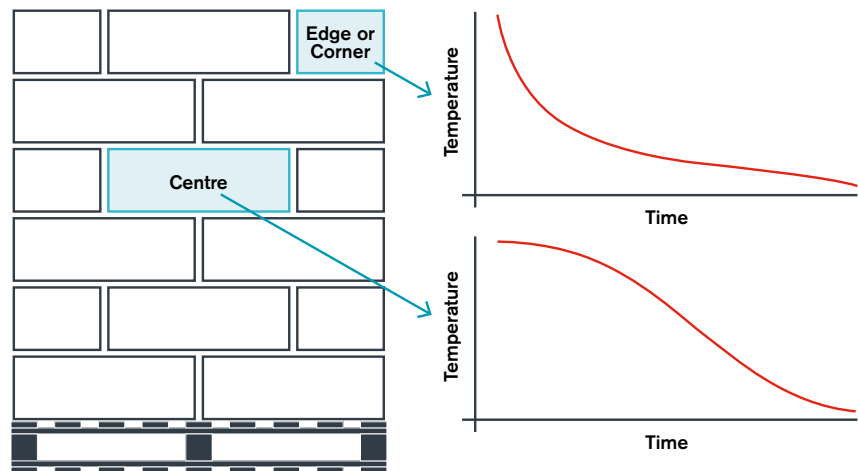

11

Post-incident investigations

In this section:

- The data logger
- In the event of a claim
- Common issues

The data logger

Almost all reefer CTU used in international trade today are fitted with data loggers. The data logger is an integrated part of the reefer control unit, and is basically a computer record of the unit's operational history. Data concerning the unit's operation is collected and stored as a database on the controller hard disk. This can be downloaded by connecting a laptop or other external device via a special download connection placed on or near the controller unit at the front of the CTU (in containers, an additional connection is located inside the CTU, behind the left front panel). For newer reefer units which are prepared for remote monitoring and control, this data can be accessed wirelessly via GPS or through closed networks.

The reefer container data logger records temperatures on an hourly basis and will normally keep records for a period of 12- 24 months, depending on the frequency of use, since more memory is used when the container is running than when it is off. For reefer trailers, the recording interval is often set between 5 to 15 minutes, whereby the records kept are shortened to a period of 1 to 6 months. The data logger continues to collect data even when the reefer is not connected to a power supply, as long as the integrated back-up battery is charged. Once the memory is full, the data logger will delete the oldest data whenever more space is needed for new data.

Usually the data logger is configured to record the temperature setting and the actual supply and return air temperature readings. For voyages where humidity control, integrated controlled atmosphere or additional cargo probes are in use, the actual readings for these are also recorded.

Other events, such as turning the power on and off, start and end of defrost cycles, active alarms or changes to the settings, are recorded and time stamped at the exact time they happen. All of this data provides an audit trail of the operation of the refrigeration machinery during transport, from pre-packing to un-packing. This data should always be downloaded and retained in case of a claim resulting from a loss of, or damage to, the cargo.

When perusing data logger printouts, it should be noted that the time is normally configured to show Greenwich Mean Time (GMT) or Coordinated Universal Time (UTC), regardless of geographical position of the container. Hence no time zone adjustments are applied, but will need to be taken into account in identifying the time of any discrepancy.

In addition to these, an extensive list of technical operational data concerning the running of the compressor, evaporator and other key components are recorded. This information is primarily used by reefer technicians providing a detailed account of the condition of the reefer machinery in connection with service and repairs.



Pharmaceutical products will have dedicated portable temperature recorders placed within the product by the shipper and these will be used for the purposes of release as described in the packaging section above.

Portable temperature recorders

The data logger is an integral component of the reefer CTU, often the property of the carrier. Unless specifically agreed in advance, this data is usually not available to the shipper and consignee, on completion of the transport.

To have immediate access to temperature data upon arrival, it is customary for shippers, especially of chilled commodities, to install portable temperature recorders within the cargo stow, that can be evaluated by the consignee as they unload the CTU.

The early portable recorders were simple mechanical devices that are still widely used.

Today, a variety of digital recorders are available. These devices are re-usable and can be re-calibrated between uses by the manufacturer. In addition to monitoring the temperature at their specific location, devices are also able to monitor humidity levels along with Oxygen and Carbon Dioxide concentrations.

Usual practice would be for the consignee to collect the portable recorder after unloading of the consignment, downloading the data manually. Devices are available that can connect via Wifi or via GPS network. Data can then be accessed before de-stuffing or even during the voyage, provided there is a GPS signal.

Common for all portable devices is that they will record the air temperature (and possibly other data) at their specific location within the cargo stow.

Depending on their position and the actual air flow at that location, it is quite normal that the temperature recorded will be slightly different from the temperatures recorded by the datalogger, that records the supply and return air as standard. Especially in live, chilled commodities, portable recorders can show temperatures that are several degrees above the requested set point, despite the container being in good running condition. When this happens it is usually due to the continuous heat production by the live product itself and/or the recorder being in a position within the stowage where the direct air circulation is restricted.

Remote Container Management (RCM)

Remote Container Management (RCM) is a remote monitoring system that was first launched by Maersk Line in September 2017. This system provides access to live data tracking during the voyage via VSAT, allowing real-time monitoring of the performance and temperature readings from anywhere in the world via a user interface. For this to work, the refrigerated container itself is fitted with a communication device or modem. While this option is still very new and only available from a small number of shipping lines, several solutions are currently available and it is expected that it will become more commonly used.



In the event of a claim

In the unlikely event that the refrigeration machinery should fail, a reefer CTU is designed to continue to provide thermal insulation to a certain degree but will not be able to prevent the internal temperature rising over time.

The insulation of modern reefer CTU is designed specifically to prevent heat transfer from the ambient air, even under extremely warm conditions. Even though the insulation capabilities decrease slightly over time, the heat transfer potential in a unit less than 10 years old, and in a good general state of repair, is very low. Subject to the doors remaining closed, any actual increase in temperature inside the unit during unavoidable off-power periods, e.g. during loading and discharge from ships and intermodal handling, will not have significant effect on the actual cargo temperatures, even if such off-power periods persist for several hours. Even so, any unavoidable off-power periods should always be kept as short as practically possible.

Furthermore, errors or discrepancies to the settings or operation are often time critical and may result in loss of or damage to the cargo. Therefore, on discovery, through checks undertaken at any point through the supply chain, a report should be made immediately to the contractual party highlighting the error or discrepancy.

Common issues include:

- An off-power period
- Incorrect temperature setting selected
- Contamination
- Theft
- Unplanned human interference

Where an issue is discovered the two key elements in the initial investigation are temperature and time. Once known, an expert should be consulted as to what the best course of action to take should be.

In such circumstances, it is good practice to involve your liability insurer at the earliest opportunity.

It is also good practice to scrutinise the contractual chain to identify (if possible) where the error has occurred with a view to holding the responsible party liable at an early stage.



Where an issue is discovered the two key elements in the initial investigation are temperature and time... in such circumstances it is good practice to involve your liability insurer at the earliest opportunity





Operational checklist

Temperature controlled cargo

Whilst the earlier chapters consider each stage of the cool supply chain in detail, below is a 12-point check list, which can serve to provide a guide to an intended shipment. If the answers to the 12 questions below are positive, then whilst it doesn't cover every eventuality, the risk of loss through the supply chain will be greatly reduced.

Has the cargo to be shipped been clearly identified?

Have any cargo specific requirements been adhered to?

Have clear instructions been received regarding the requirements of the transport?

Have you selected the most appropriate CTU for the cargo and transport?

Has the pre-trip inspection been undertaken and the CTU passed?

Is the CTU clean and free from debris and pests?

Has the cargo been appropriately packaged for the intended transport in the intended reefer CTU?

Has the subject cargo been pre-cooled?

Has the reefer CTU been correctly set in terms of temperature, ventilation, humidity and controlled atmosphere?

Has the subject cargo been packed and secured correctly within the CTU?

Has the CTU been sealed?

Have all received instructions been passed accurately to all stakeholders through the intended supply chain?

Glossary of terms

Cargo transport unit (CTU)

A freight container, swap body, vehicle, railway wagon or any other similar unit in particular when used in intermodal transport.

Carrier

The party who, in a contract of carriage, undertakes to perform or to procure the performance of carriage by rail, road, sea, inland waterway or by a combination of such modes. Can be further classified as:

- Road haulier
- Rail operator
- Shipping line

Consignee

The party to whom a cargo is consigned under a contract of carriage or a transport document or electronic transport record. Also known as the receiver.

Consignor

The party who prepares a consignment for transport. If the consignor contracts the transport operation with the carrier, the consignor will undertake the function of the shipper and may also be known as:

- The shipper (maritime)
- The sender (road transport)

Consolidator

The party performing a consolidation service for others.

CTU operator

The party who owns or operates the CTU and provides empty CTUs to the consignor/shipper/packer.

Freight forwarder

The party who organises shipments for individuals or other companies and may also act as a carrier. When the freight forwarder is not acting as a carrier, it acts only as an agent, in other words as a third-party logistics provider who dispatches shipments via carriers and that books or otherwise arranges space for these shipments.

Intermodal operator

The party who provides a service to transfer and/or stow CTUs. May be subdivided into:

- Maritime terminal operator
- Rail terminal
- Inland waterway port

Packaging

Receptacles and any other components or materials necessary for the receptacle to perform its containment function.

Package

The complete product of the packing operation, consisting of the packaging and its contents as prepared for transport.

Packer

The party that loads, places or fills the cargo within or on the CTU; the packer may be contracted either by the consignor, by the shipper, by the freight forwarder or by the carrier; if the consignor or the shipper packs a CTU within his own premises, the consignor or the shipper is also the packer.

Set point

Temperature setting on the controller of the refrigeration unit.

Shipper

The party named on the bill of lading or waybill as shipper and/or who concludes a contract of carriage (or in whose name or on whose behalf a contract of carriage has been concluded) with a carrier. Also known as the sender.

For more information

Please contact us at riskmanagement@ttclub.com
or visit us as ttclub.com

TT Club

TT Club is the established market-leading independent provider of mutual insurance and related risk management services to the international transport and logistics industry. TT Club's primary objective is to help make the industry safer and more secure. Founded in 1968, the Club has more than 1100 Members, spanning container owners and operators, ports and terminals, and logistics companies, working across maritime, road, rail, and air. TT Club is renowned for its high-quality service, in-depth industry knowledge and enduring Member loyalty. It retains more than 93% of its Members with a third of its entire membership having chosen to insure with the Club for 20 years or more.

ttclub.com

UK P&I Club

UK P&I Club is a leading provider of P&I insurance and other services to the international shipping community. Established in 1865, the UK P&I Club insures over 240 million tonnes of owned and chartered shipping through its international offices and claims network. 'A (Stable)' rated by Standard & Poor's with free reserves and hybrid capital of \$597m, the UK P&I Club is renowned for its specialist skills and expertise that ensure 'best in class' underwriting, claims handling and loss prevention services.

ukpandi.com

Thomas Miller

TT Club is managed by Thomas Miller, an independent and international provider of market leading insurance services. Most of the businesses we currently own or manage are acknowledged leaders in their chosen market. Our portfolio includes mutual organisations and, increasingly, specialist insurance services businesses.

thomasmiller.com

ttclub.com